



NEVO600 SERIES



- Modular
- Configurable



600 watt in the palm of your hand

The NEVO 600 is a modular and user configurable power supply offering unrivalled performance and flexibility. Delivering up to 600 watts from a 600 gram 5" x 3" x 1U package, the NEVO is the ultimate power solution for applications where size and weight are vital factors. Each system consists of an input module together with up to eight isolated output modules. The series carry full UL60601 3rd edition safety approvals and comply with EN61000-3, EN61000-4 and EN550022-B EMC standards.



MAIN FEATURES:

- ✓ 600 watt output
- ✓ 5" x 3" x 1U footprint
- ✓ High power density (25W/in³)
- ✓ Medical approvals (3rd Ed)
- ✓ High reliability
- ✓ High efficiency – up to 89%
- ✓ Only 0.6kg – 100W/kg
- ✓ I²C control option
- ✓ Remote current/voltage programming
- ✓ Accurate current sharing
- ✓ Current output signal
- ✓ 5V 200mA bias supply
- ✓ RoHS compliant
- ✓ Field configurable
- ✓ Two year warranty

SYSTEM SPECIFICATIONS

INPUT ELECTRICAL						
Parameter	Details	Min	Typ	Max	Units	
AC Input Voltage	Nominal range is 100Vrms to 240Vrms	85		264	Vrms	
AC Input Frequency	Contact factory for 400Hz operation.	47	50/60	63	Hz	
DC Input Voltage	Medical	120		300	Vdc	
Power Rating	See graphs for deratings			600	Watts	
Input Current	600Watts output at 180Vrms input			4	Amps	
Inrush Current	265Vrms (cold start)			20	Amps	
Fusing	5x20 Fast acting			5	Amps	
Input Current Limit	Maintains power factor		6		Amps	
Efficiency	See graphs		86	89	%	
Idle Power	All outputs fitted and enabled		28		Watts	
Idle Power	All outputs fitted and Disabled		21		Watts	
Power Factor	Typical value for 300Watts output at 240Vrms input		0.96	0.99		
Holdup	600Watts output at 180Vrms input	17	20	21	mS	
UVLO	Turn on only	78		84	Vrms	
Over temperature	Internally monitored. Latching	115		125	°C	
Reliability	40°C 80% load			2	FPMH	
Signals	Bias Voltage	4.8	5	5.2	V	
	Bias current	0		200	mA	
	Power Good voltage	PNP open collector with internal 10k pull down resistor	8	10	15	V
	Power Good current		0		20	mA
	Inhibit voltage		2		15	V
	Inhibit current	10k ohm input impedance	0.2		1.5	mA
	Global inhibit voltage		3		15	V
	Global inhibit current	5k ohm input impedance	0.6		3	mA
	AC_OK voltage		1		4	V
	AC_OK current		-10		20	mA
AC_OK warning	See user manual for exceptions	5			mS	

INSTALLATION			
Parameter	Details	Parameter	Details
Equipment class	I	Flammability rating	94V-2
Installation category	II	IP Rating	IP10
Pollution degree	2	ROHS Compliance	2002/95/EC
Material group	IIIb (indoor use only)		

RELIABILITY				
Component	Details	Min	Max	Units
FAN	Mag Lev Std		3.8	FPMH
INPUT	Excluding FAN		2	FPMH
OUTPUT	See individual output datasheets		1	FPMH
Warranty			2	Years

SAFETY				
Parameter	Details	Min	Max	Units
Isolation Voltage	Input to Output		4000	Vac
	Input to Chassis		1500	Vac
	Output to Chassis		250	Vdc
Isolation Clearance	Output to Output		250	Vdc
	Primary to Secondary (Reinforced)	7		mm
Isolation Creepage	Primary to Chassis (Basic)	2.5		mm
	Primary to Secondary (Reinforced)	12		mm
Leakage Current	Primary to Chassis (Basic)	4		mm
	Medical: 265Vac, 63Hz, 25°C		300	uA

MECHANICAL	
Parameter	Details
Size	77.7mm x 129.7mm x 41.0mm (all external dimensions ± 1.0mm)
Weight	360 gram +60 gram per output module
Mounting	Bottom or Side mounting (See diagram for details)



MEDICAL DATASHEET

NEVO600 SERIES



ENVIRONMENTAL					
	Parameter	Details	Min	Max	Units
Storage	Temperature		-40	+85	°C
	Humidity	Relative, non-condensing	5	95	%
	Altitude		-200	5000	m
	Air Pressure		54	106	kPa
Operation	Temperature	Full power	-20	50	°C
		Derate input and outputs at 2.5%/°C	50	70	°C
	Humidity	Relative, non-condensing	5	95	%
	Altitude	(-200 to 2000m for UL60601-1)	-200	3000	m
	Air Pressure		78	106	kPa
	Noise Level	Measured 1m from fan intake		45	dba
	Shock	3000 bumps at 10G (16ms) half sine wave			
Vibration	1.5G 10 to 200Hz sine wave, 20G for 15min in 3 axes random vibration				

EMC			
	Parameter	Standard	Level
Emissions	Radiated electric field	EN55011, EN55022, FCC	B
	Conducted emissions	EN55011, EN55022, FCC	B
	Harmonic Distortion	EN61000-3-2	Compliant
	Flicker & Fluctuation	EN61000-3-3	Compliant
Immunity	Electrostatic discharge	EN61000-4-2 (15kV air, 8kV contact)	4
	Radiated RFI	EN61000-4-3 (10V/m)	3
	Fast Transient burst	EN61000-4-4 (4kV)	4
	Input line surges	EN61000-4-5 (1kV L-N, 2kV L-E)	3
	Conducted RFI	EN61000-4-6 (10V)	4
	Power Freq. Magnetic Field	EN61000-4-8 (10A/m)	3
	Voltage Dips	EN61000-4-11 (EN55024)	Compliant

Typical Conducted Emmissions

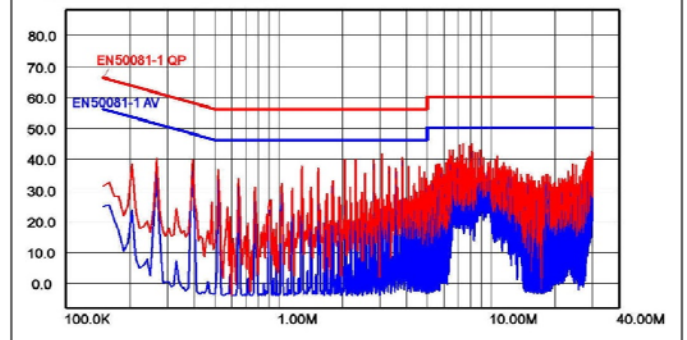

AGENCY APPROVALS			
Standard	Details	Standard	Details
IEC/EN60601-1 ED3			
UL60601-1 ED3			
CSA-C22.2 No. 60601-1-08			
CE MARK	LVD 73/23/EEC	UL file number	UL: E316486

CB certificate and report available on request

Typical Load Efficiency

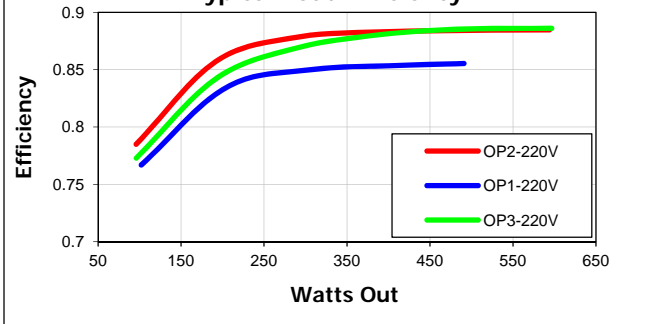

Typical Line Efficiency

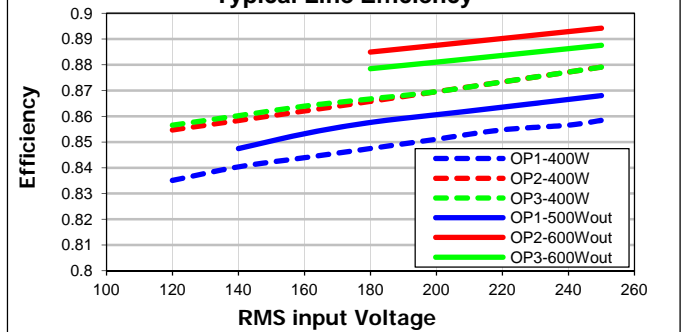

Line Derating



Temperature Derating

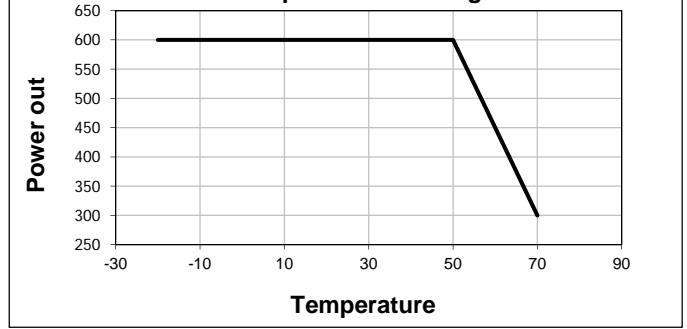

MECHANICAL DIMENSIONS AND MOUNTING SCREWS

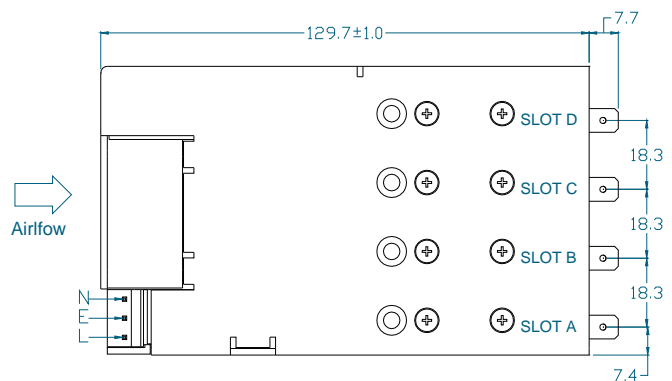
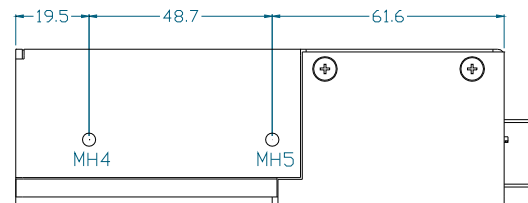
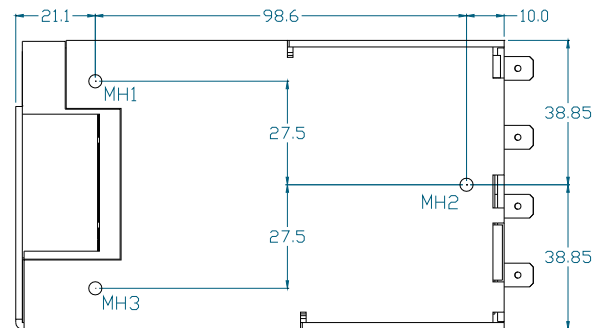
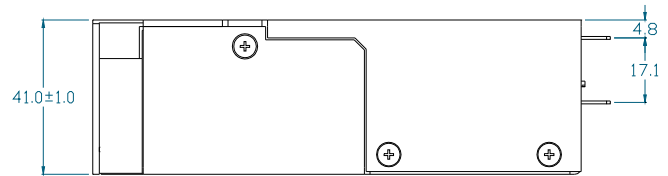
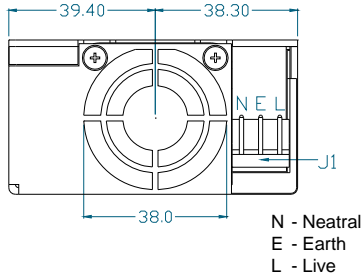

SCREWS	
MH1, MH2, MH3, MH4, MH5	
Screw type	M4
Tightening	Tighten to 1.5 Nm
Penetration depth	4.00mm max including chassis
OUTPUT MODULES x 8	
Screw type	M3x5, C/Sink, Posi, Stainless Steel
Tightening	Tighten to 0.75 Nm
Penetration depth	Defined by screw
CHASSIS x 5	
Screw type	M3x5, C/Sink, Posi, Stainless Steel
Tightening	Tighten to 0.75 Nm
Penetration depth	Defined by screw
FAN x 2	
Screw type	M3x24, C/Sink, Posi, Stainless Steel
Tightening	Tighten to 0.75 Nm
Penetration depth	Defined by screw

CONNECTORS

PINOUTS		
J1		
Circuit	Details	
1	Live	
2	Earth	
3	Neutral	
J2		
Circuit	Details	
1	Power Good	Slot A
2	Inhibit	
3	Power Good	Slot B
4	Inhibit	
5	Power Good	Slot C
6	Inhibit	
7	Power Good	Slot D
8	Inhibit	
9	Global Inhibit	
10	AC OK	
11	+5V 200mA Bias Supply	
12	COM	
J5		
Circuit	Details	
1	-Sense	
2	+Sense	
3	Voltage Control	
4	Current Control / Share / Out	
5	COM	
6	+5V local bias supply	

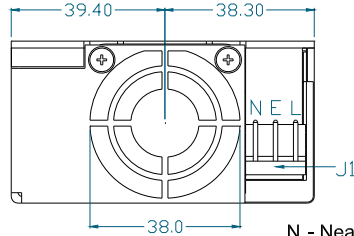

N - Neutral
E - Earth
L - Live

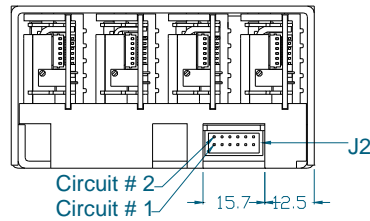

J3
Positive Output
J4
Negative Output

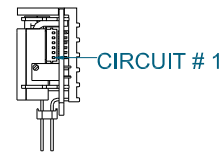
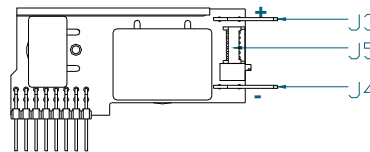

REF.	DETAILS	MANUFACTURER		TERMINAL
J1	MAINS INPUT: 3 Pin, 5.08mm, with Friction Lock, 18-24 AWG	MOLEX	010013036	8701031
J2	GLOBAL SIGNALS: 12 Pin, 2mm, with Friction Lock, 24-30 AWG	MOLEX	511101260	503948051
J3/4(1)	OUTPUT POWER TERMINAL: TAB SIZE 6.35mmx0.8mm	VARIOUS		VARIOUS
J5	OUTPUT SIGNALS: 6 Pin, 1.25mm, with Friction lock, 28-32 AWG	MOLEX	1510210600	50058800

Notes

- Terminal and Wire current rating must exceed maximum short circuit output current. Eg. Output 1 = 25A*1.25 = 31.25Amps
- Direct equivalents may be used for any connector parts
- All cables must be rated 105°C min, equivalent to UL1015

PART NUMBERING SYSTEM

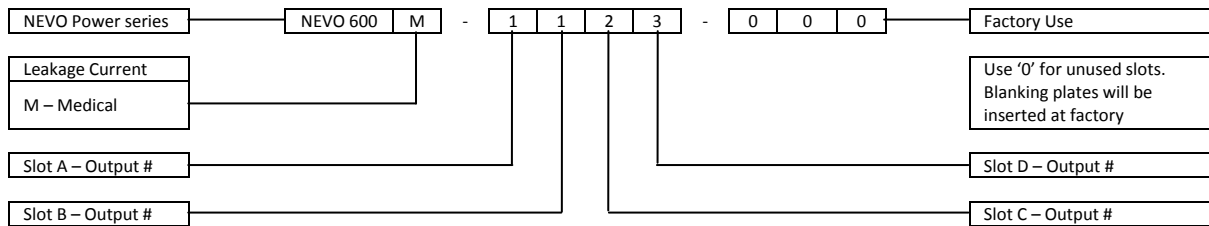

When initially ordering non-nominal voltage settings add "/Voltage" after each output # where a special voltage setting is required
E.g. If 3.30Vdc is required in slot B and all other slots require nominal voltages then use:

NEVO 600M - 1 - 1/3.30 - 2 - 3

The factory will then issue a 3 digit code for your specific configuration that can be used for all future orders of the same configuration
When ordering an input unit with no outputs inserted, simply order NEVO 600M

Vox Power Ltd. reserves the right to change or improve any part of the specification, electrical or mechanical design or manufacturing process without notice. Please consult your local distributor or contact Vox Power to ensure that you have the latest specification before using your product. For other information relating to the use of the product please refer to the latest NEVO user manual. Vox Power reserves the right to make changes without notice to any of its products. Vox Power does not assume any liability arising out of the use or application of any of its products and of any information to the maximum extent permitted by law. No license, express or implied, by estoppel or otherwise, to any intellectual property rights is granted by this document or by any conduct of Vox Power. VOX POWER DISCLAIMS ALL WARRANTIES AND REPRESENTATIONS. IN PARTICULAR ALL OTHER WARRANTIES, CONDITION OR TERMS RELATING TO SUITABILITY, FITNESS FOR PURPOSE, MECHANICALITY OR CONDITION OF THE PRODUCTS AND WHETHER EXPRESS OR IMPLIED BY STATUTE OR COMMON LAW OR OTHERWISE ARE EXCLUDED.

Document DOC6005 rev 04

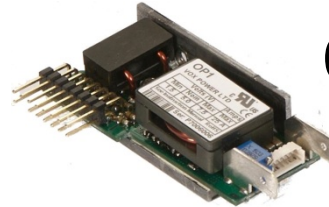
OUTPUT 1 SPECIFICATIONS

Parameter	Details	Min	Typ	Max	Units
Output voltage range	See table	1.5	5	7.5	V
Rated current				25	A
Average output power				125	Watts
Peak output power	See graph, < 5 seconds 50% duty cycle			187.5	Watts
Initial voltage accuracy	Factory set units	-0.5		0.5	%
Manual Voltage Adjust	11 turn potentiometer		0.545		V/turn
Load Regulation	Measured at sense terminals	-50		50	mV
Line Regulation	Measured at sense terminals	-0.1		0.1	%Vnom
Cross Regulation	Measured at sense terminals	-0.2		0.2	%Vnom
Minimum Load				0	Watts
Temperature coefficient		-0.02		0.02	%/°C
Ripple and Noise	20MHz BW, pk-pk			1	%Vnom
Transient response	25% to 75% load transient at 1A/us Recovery to within 10% of Vset			1	V
Turn on rise time	Monotonic 10% to 90%	1.5		3.5	mS
Turn on overshoot				0.1	%Vset
Turn on delay	AC to PG En to PG		600 15	750 20	mS mS
Current share accuracy				5	%Imax
Open sense offset	Open sense, voltage offset due to bias currents			2	%Vnom
Holdup voltage				6	V
Isolation to ground	Each terminal			250	V
Over current protection	% of rated current	105		125	%rated
Reverse current protection	% of rated current	-6		0	%rated
Short circuit protection (Hiccup mode)	Period Duty cycle Voltage threshold (Measured at sense terminals)		125 3 1		mS % V
Over voltage protection	Latching		9.5		V
Over Temperature protection	Internally monitored. Latching	115		125	°C
Sense cable protection	Positive Negative	-1		2 1	V V
Power Good threshold	Low threshold only		90		%Vset
Current output signal	$I_{SIG} = 0.6 \cdot I_{OUT} / (I_{RTD} \cdot 1.25)$	0		110	%Irated
Current limit control	$I_{LMT} = (V_{CTRL} - 0.6) \cdot I_{RTD} \cdot 1.25$	0		110	%Irated
Remote voltage control	$V_{OUT} = V_{SET} \cdot ((1.8 - V_{CTRL}) / 0.6)$	0		300	%Vset
Bias supply	10mA max	4.5	5	5.2	V
Reliability	40°C 80% load			1	FPMH
Warranty				2	Years
Wire Size		12	10		AWG
Weight				60	Grams
Size	60mm x 35mm x 17mm				

Notes: All specifications are believed to be correct at time of publication and are subject to change without notice.

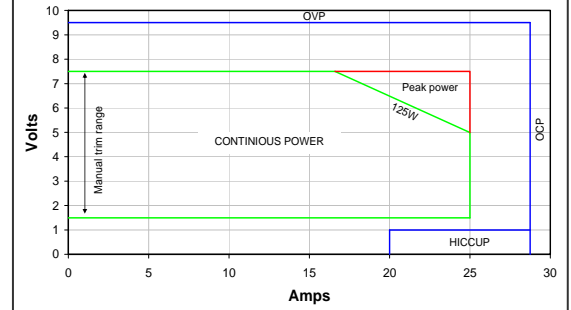
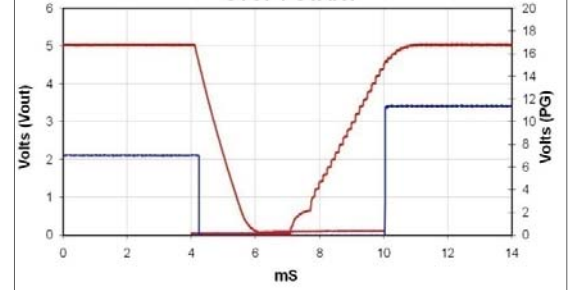
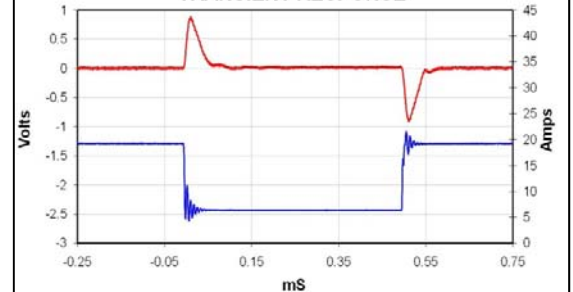
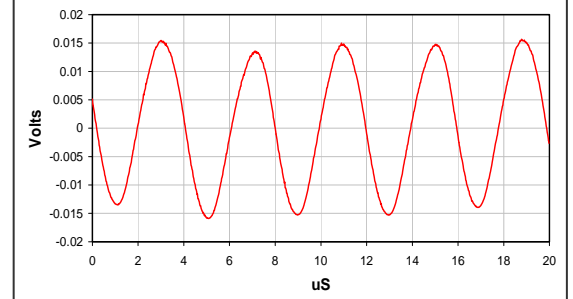
OUTPUT 1 POWER PROFILE

STOP / START

TRANSIENT RESPONSE

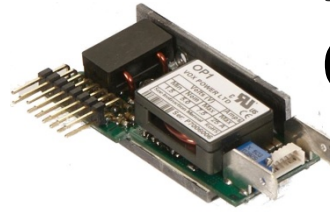
RIPPLE

Vox Power Ltd. reserves the right to change or improve any part of the specification, electrical or mechanical design or manufacturing process without notice. Please consult your local distributor or contact Vox Power to ensure that you have the latest specification before using your product. For other information relating to the use of the product please refer to the latest NEVO user manual. Vox Power reserves the right to make changes without notice to any of its products. Vox Power does not assume any liability arising out of the use or application of any of its products and of any information to the maximum extent permitted by law. No license, express or implied, by estoppel or otherwise, to any intellectual property rights is granted by this document or by any conduct of Vox Power. VOX POWER DISCLAIMS ALL WARRANTIES AND REPRESENTATIONS. IN PARTICULAR ALL OTHER WARRANTIES, CONDITION OR TERMS RELATING TO SUITABILITY, FITNESS FOR PURPOSE, MECHANICALITY OR CONDITION OF THE PRODUCTS AND WHETHER EXPRESS OR IMPLIED BY STATUTE OR COMMON LAW OR OTHERWISE ARE EXCLUDED.

Document DOC6002 rev 02



Patents pending

OUTPUT 2 SPECIFICATIONS

Parameter	Details	Min	Typ	Max	Units
Output voltage range	See table	4.5	12	15	V
Rated current				15	A
Average output power				150	Watts
Peak output power	See graph, < 5 seconds 50% duty cycle			225	Watts
Initial voltage accuracy	Factory set units	-0.5		0.5	%
Manual Voltage Adjust	11 turn potentiometer		0.954		V/turn
Load Regulation	Measured at sense terminals	-100		100	mV
Line Regulation	Measured at sense terminals	-0.1		0.1	%Vnom
Cross Regulation	Measured at sense terminals	-0.2		0.2	%Vnom
Minimum Load				0	Watts
Temperature coefficient		-0.02		0.02	%/°C
Ripple and Noise	20MHz BW, pk-pk			1	%Vnom
Transient response	25% to 75% load transient at 0.5A/uS			1.5	V
	Recovery to within 10% of Vset			100	uS
Turn on rise time	Monotonic 10% to 90%	1.5		3.5	mS
Turn on overshoot				0.1	%Vset
Turn on delay	AC to PG		600	750	mS
	En to PG		15	20	mS
Current share accuracy				5	%Imax
Open sense offset	Open sense, voltage offset due to bias currents			2	%Vnom
Holdup voltage				12.5	V
Isolation to ground	Each terminal			250	V
Over current protection	% of rated current	105		125	%rated
Reverse current protection	% of rated current	-6		0	%rated
Short circuit protection (Hiccup mode)	Period		125		mS
	Duty cycle		3		%
	Voltage threshold (Measured at sense terminals)		2		V
Over voltage protection	Latching		18		V
Over Temperature protection	Internally monitored. Latching	115		125	°C
Sense cable protection	Positive	-1		2	V
	Negative			1	V
Power Good threshold	Low threshold only		90		%Vset
Current output signal	$I_{SIG} = 0.6 + I_{OUT} / (I_{RTD} * 1.25)$	0		110	%Irated
Current limit control	$I_{LMT} = (V_{CTRL} - 0.6) * I_{RTD} * 1.25$	0		110	%Irated
Remote voltage control	$V_{OUT} = V_{SET} * ((1.8 - V_{CTRL}) / 0.6)$	0		300	%Vset
Bias supply	10mA max	4.5	5	5.2	V
Reliability	40°C 80% load			1	FPMH
Warranty				2	Years
Wire Size		16	14	10	AWG
Weight				60	Grams
Size	60mm x 35mm x 17mm				

Notes: All specifications are believed to be correct at time of publication and are subject to change without notice.

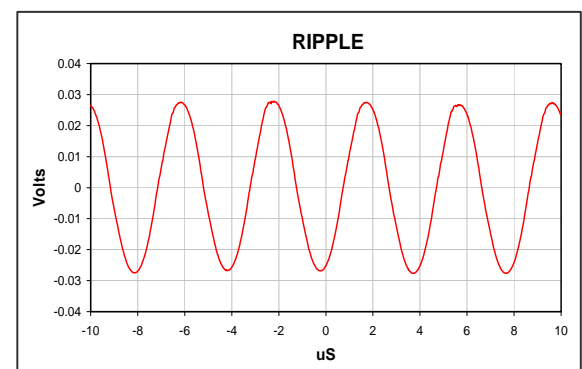
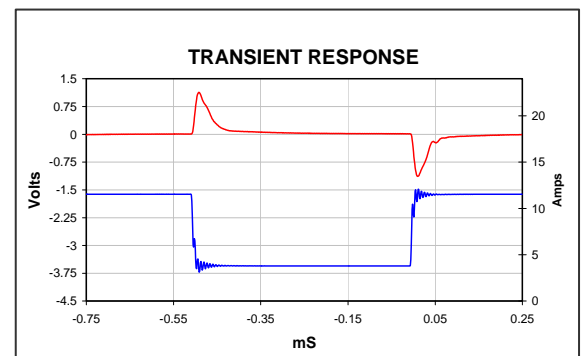
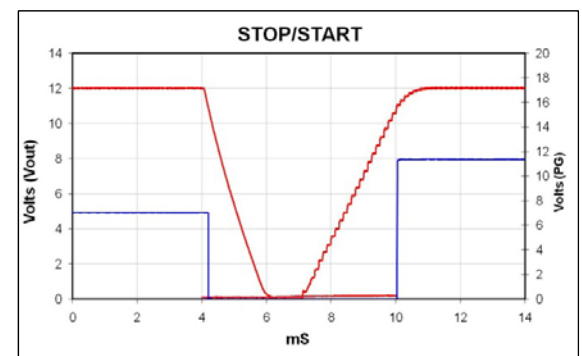
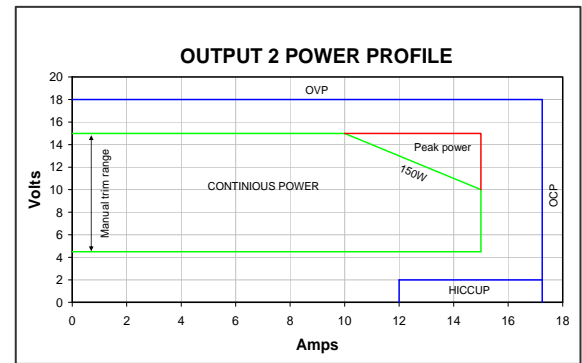

Vox Power Ltd. reserves the right to change or improve any part of the specification, electrical or mechanical design or manufacturing process without notice. Please consult your local distributor or contact Vox Power to ensure that you have the latest specification before using your product. For other information relating to the use of the product please refer to the latest NEVO user manual. Vox Power reserves the right to make changes without notice to any of its products. Vox Power does not assume any liability arising out of the use or application of any of its products and of any information to the maximum extent permitted by law. No license, express or implied, by estoppel or otherwise, to any intellectual property rights is granted by this document or by any conduct of Vox Power. VOX POWER DISCLAIMS ALL WARRANTIES AND REPRESENTATIONS. IN PARTICULAR ALL OTHER WARRANTIES, CONDITION OR TERMS RELATING TO SUITABILITY, FITNESS FOR PURPOSE, MECHANABILITY OR CONDITION OF THE PRODUCTS AND WHETHER EXPRESS OR IMPLIED BY STATUTE OR COMMON LAW OR OTHERWISE ARE EXCLUDED.

Document DOC6003 rev 02



OUTPUT 3 SPECIFICATIONS

Parameter	Details	Min	Typ	Max	Units
Output voltage range	See table	9	24	30	V
Rated current				7.5	A
Average output power				150	Watts
Peak output power	See graph, < 5 seconds 50% duty cycle			225	Watts
Initial voltage accuracy	Factory set units	-0.5		0.5	%
Manual Voltage Adjust	11 turn potentiometer		1.9		V/turn
Load Regulation	Measured at sense terminals	-150		150	mV
Line Regulation	Measured at sense terminals	-0.1		0.1	%Vnom
Cross Regulation	Measured at sense terminals	-0.2		0.2	%Vnom
Minimum Load				0	Watts
Temperature coefficient		-0.02		0.02	%/°C
Ripple and Noise	20MHz BW, pk-pk			1	%Vnom
Transient response	25% to 75% load transient at 0.25A/uS			3	V
	Recovery to within 10% of Vset			100	uS
Turn on rise time	Monotonic 10% to 90%	1.5		3.5	mS
Turn on overshoot				0.1	%Vset
Turn on delay	AC to PG		600	750	mS
	En to PG		15	20	mS
Current share accuracy				5	%Imax
Open sense offset	Open sense, voltage offset due to bias currents			2	%Vnom
Holdup voltage				25	V
Isolation to ground	Each terminal			250	V
Over current protection	% of rated current	105		125	%rated
Reverse current protection	% of rated current	-6		0	%rated
Short circuit protection (Hiccup mode)	Period		125		mS
	Duty cycle		3		%
	Voltage threshold (Measured at sense terminals)		3.5		V
Over voltage protection	Latching		36		V
Over Temperature protection	Internally monitored. Latching	115		125	°C
Sense cable protection	Positive	-1		2	V
	Negative			1	V
Power Good threshold	Low threshold only		90		%Vset
Current output signal	$I_{SIG} = 0.6 \cdot I_{OUT} / (I_{RTD} \cdot 1.25)$	0		110	%Irated
Current limit control	$I_{LMT} = (V_{CTRL} - 0.6) \cdot I_{RTD} \cdot 1.25$	0		110	%Irated
Remote voltage control	$V_{OUT} = V_{SET} \cdot ((1.8 - V_{CTRL}) / 0.6)$	0		300	%Vset
Bias supply	10mA max	4.5	5	5.2	V
Reliability	40°C 80% load			1	FPMH
Warranty				2	Years
Wire Size		20	18	10	AWG
Weight				60	Grams
Size	60mm x 35mm x 17mm				

Notes: All specifications are believed to be correct at time of publication and are subject to change without notice.

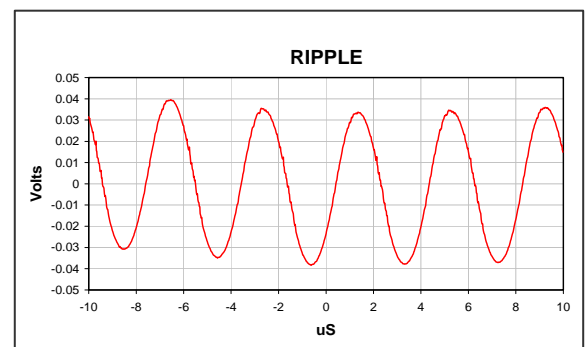
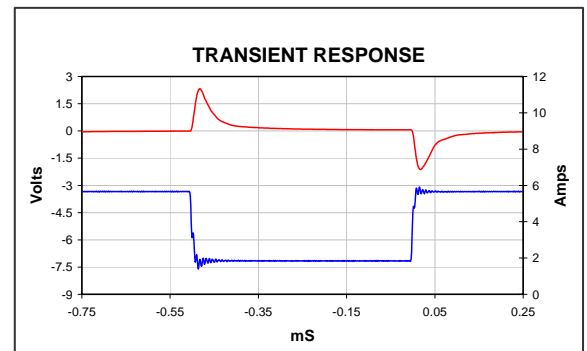
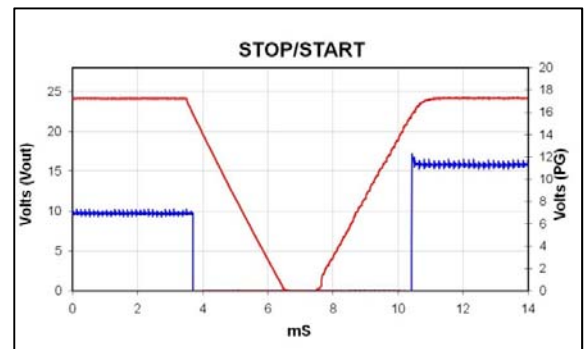
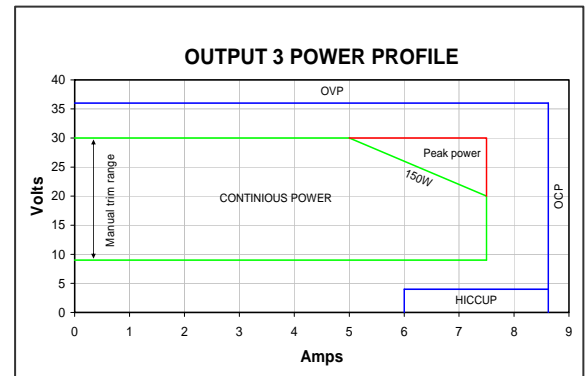

Vox Power Ltd. reserves the right to change or improve any part of the specification, electrical or mechanical design or manufacturing process without notice. Please consult your local distributor or contact Vox Power to ensure that you have the latest specification before using your product. For other information relating to the use of the product please refer to the latest NEVO user manual. Vox Power reserves the right to make changes without notice to any of its products. Vox Power does not assume any liability arising out of the use or application of any of its products and of any information to the maximum extent permitted by law. No license, express or implied, by estoppel or otherwise, to any intellectual property rights is granted by this document or by any conduct of Vox Power. VOX POWER DISCLAIMS ALL WARRANTIES AND REPRESENTATIONS. IN PARTICULAR ALL OTHER WARRANTIES, CONDITION OR TERMS RELATING TO SUITABILITY, FITNESS FOR PURPOSE, MECHANABILITY OR CONDITION OF THE PRODUCTS AND WHETHER EXPRESS OR IMPLIED BY STATUTE OR COMMON LAW OR OTHERWISE ARE EXCLUDED.

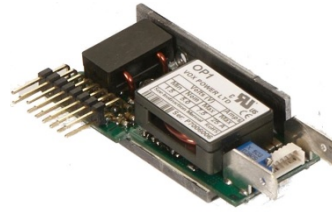
OUTPUT 4 SPECIFICATIONS

Parameter	Details	Min	Typ	Max	Units
Output voltage range	See table	18	48	58	V
Rated current				3.75	A
Average output power				150	Watts
Peak output power	See graph, < 5 seconds 50% duty cycle			225	Watts
Initial voltage accuracy	Factory set units	-0.5		0.5	%
Manual Voltage Adjust	11 turn potentiometer		3.6		V/turn
Load Regulation	Measured at sense terminals	-300		300	mV
Line Regulation	Measured at sense terminals	-0.1		0.1	%Vnom
Cross Regulation	Measured at sense terminals	-0.2		0.2	%Vnom
Minimum Load				0	Watts
Temperature coefficient		-0.02		0.02	%/°C
Ripple and Noise	20MHz BW, pk-pk			1	%Vnom
Transient response	25% to 75% load transient at 0.25A/uS			3	V
	Recovery to within 10% of Vset			100	uS
Turn on rise time	Monotonic 10% to 90%	1.5		3.5	mS
Turn on overshoot				0.1	%Vset
Turn on delay	AC to PG		600	750	mS
	En to PG		15	20	mS
Current share accuracy				5	%Imax
Open sense offset	Open sense, voltage offset due to bias currents			2	%Vnom
Holdup voltage				50	V
Isolation to ground	Each terminal			250	V
Over current protection	% of rated current	105		125	%rated
Reverse current protection	% of rated current	-6		0	%rated
Short circuit protection (Hiccup mode)	Period		125		mS
	Duty cycle		3		%
	Voltage threshold (Measured at sense terminals)		3.5		V
Over voltage protection	Latching		66		V
Over Temperature protection	Internally monitored. Latching	115		125	°C
Sense cable protection	Positive	-3		3	V
	Negative			2	V
Power Good threshold	Low threshold only		90		%Vset
Current output signal	$I_{SIG} = 0.6 \cdot I_{OUT} / (I_{RTD} \cdot 1.25)$	0		110	%rated
Current limit control	$I_{LMT} = (V_{CTRL} - 0.6) \cdot I_{RTD} \cdot 1.25$	0		110	%rated
Remote voltage control	$V_{OUT} = V_{SET} \cdot ((1.8 - V_{CTRL}) / 0.6)$	0		300	%Vset
Bias supply	10mA max	4.5	5	5.2	V
Reliability	40°C 80% load			1	FPMH
Warranty				2	Years
Wire Size		20	18	10	AWG
Weight				60	Grams
Size	60mm x 35mm x 17mm				

Notes: All specifications are believed to be correct at time of publication and are subject to change without notice.

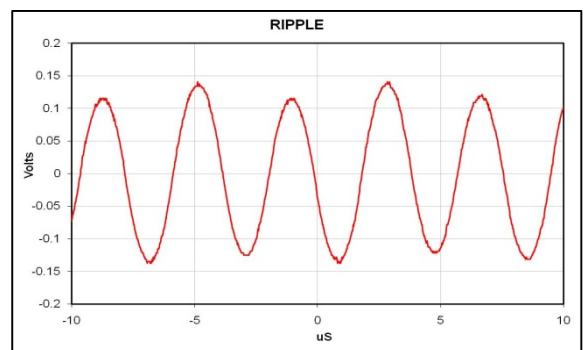
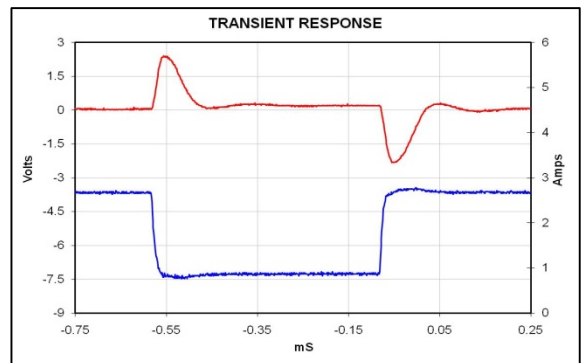
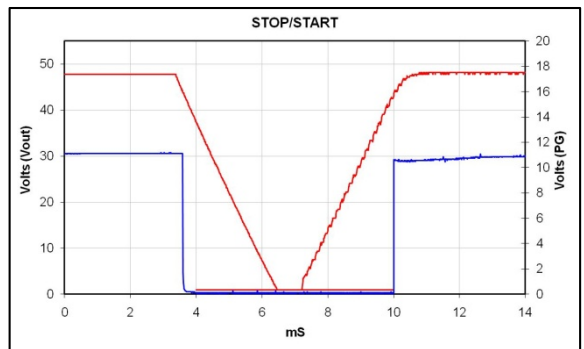
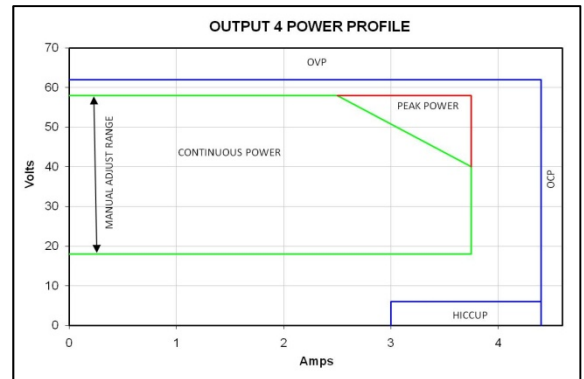

Vox Power Ltd. reserves the right to change or improve any part of the specification, electrical or mechanical design or manufacturing process without notice. Please consult your local distributor or contact Vox Power to ensure that you have the latest specification before using your product. For other information relating to the use of the product please refer to the latest NEVO user manual. Vox Power reserves the right to make changes without notice to any of its products. Vox Power does not assume any liability arising out of the use or application of any of its products and of any information to the maximum extent permitted by law. No license, express or implied, by estoppel or otherwise, to any intellectual property rights is granted by this document or by any conduct of Vox Power. VOX POWER DISCLAIMS ALL WARRANTIES AND REPRESENTATIONS. IN PARTICULAR ALL OTHER WARRANTIES, CONDITION OR TERMS RELATING TO SUITABILITY, FITNESS FOR PURPOSE, MERCHANTABILITY OR CONDITION OF THE PRODUCTS AND WHETHER EXPRESS OR IMPLIED BY STATUTE OR COMMON LAW OR OTHERWISE ARE EXCLUDED.

Document DOC6006 rev 01



OUTPUT 5 SPECIFICATIONS

Parameter	Details	Min	Typ	Max	Units
Output voltage range	Each channel	5	12	15	V
Rated current	Each channel			5	A
Rated power	Each channel		60	75	Watts
Initial voltage accuracy	Factory set units	-1		1	%
Manual Voltage Adjust	11 turn potentiometer		0.9		V/turn
Load Regulation	Measured at sense terminals	-50		50	mV
Line Regulation	Measured at sense terminals	-0.1		0.1	%Vnom
Cross Regulation	Measured at sense terminals	-0.2		0.2	%Vnom
Minimum Load				0	Watts
Temperature coefficient		-0.02		0.02	%/°C
Ripple and Noise	20MHz BW, pk-pk			2	%Vset
Transient response (Vset = 5V)	25% to 75% load transient at 1A/uS			1	V
	Recovery to within 10% of Vset			100	uS
Turn on rise time	Monotonic 10% to 90%	1.5		3.5	mS
Turn on overshoot				0.1	%Vset
Turn on delay	AC to PG		600	750	mS
	En to PG		30	40	mS
Holdup voltage				12	V
Isolation to ground	Each terminal			250	V
Over current protection	Hiccup mode only	105		130	%rated
Reverse current protection	None				
Short circuit protection (Hiccup mode)	Period		30		mS
	Duty cycle		1		%
Over voltage protection	Latching		20		V
Over Temperature protection	Internally monitored. Latching	115		125	°C
Power Good thresholds	High and Low window	68		120	%Vset
Reliability	25°C, 100% load, Telcordia			1	FPMH
Warranty				2	Years
Wire Size		20	18	10	AWG
Weight				60	Grams
Size	60mm x 35mm x 17mm				

Notes: All specifications are believed to be correct at time of publication and are subject to change without notice.

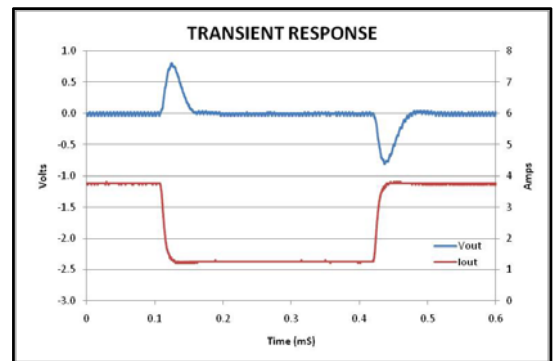
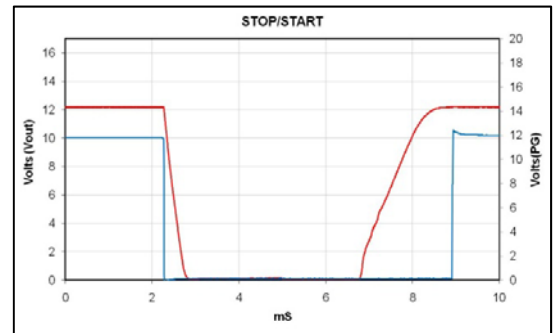
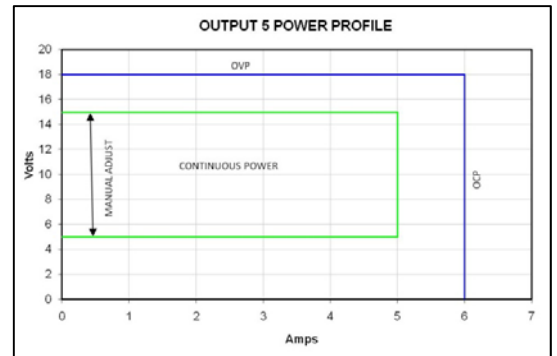

J5	
Circuit	Details
1	Top + Sense
2	Top - Sense
3	Open
4	Bottom + Sense
5	Bottom - Sense

REF.	DETAILS	MANUFACTURER	HOUSING	TERMINAL
J1	OUTPUT POWER CONNECTOR: 4 Pin, with Friction lock, 20-24 AWG	MOLEX	430250400	430300001

Notes: 1. Terminal and Wire current rating must exceed maximum output current. 2. Direct equivalents may be used for any connector parts 3. All cables must be rated 105°C min, equivalent to UL1015

Vox Power Ltd. reserves the right to change or improve any part of the specification, electrical or mechanical design or manufacturing process without notice. Please consult your local distributor or contact Vox Power to ensure that you have the latest specification before using your product. For other information relating to the use of the product please refer to the latest NEVO user manual. Vox Power reserves the right to make changes without notice to any of its products. Vox Power does not assume any liability arising out of the use or application of any of its products and of any information to the maximum extent permitted by law. No license, express or implied, by estoppel or otherwise, to any intellectual property rights is granted by this document or by any conduct of Vox Power. VOX POWER DISCLAIMS ALL WARRANTIES AND REPRESENTATIONS. IN PARTICULAR ALL OTHER WARRANTIES, CONDITION OR TERMS RELATING TO SUITABILITY, FITNESS FOR PURPOSE, MECHANICALITY OR CONDITION OF THE PRODUCTS AND WHETHER EXPRESS OR IMPLIED BY STATUTE OR COMMON LAW OR OTHERWISE ARE EXCLUDED.



OUTPUT 6 SPECIFICATIONS

Parameter	Details	Min	Typ	Max	Units
Output voltage range	Each channel	1.8	3.3	5	V
Rated current	Each channel			5	A
Rated power	Each channel		16.5	25	Watts
Initial voltage accuracy	Factory set units	-1		1	%
Manual Voltage Adjust	11 turn potentiometer		0.3		V/turn
Load Regulation	Measured at sense terminals	-50		50	mV
Line Regulation	Measured at sense terminals	-0.1		0.1	%Vnom
Cross Regulation	Measured at sense terminals	-0.2		0.2	%Vnom
Minimum Load				0	Watts
Temperature coefficient		-0.02		0.02	%/°C
Ripple and Noise	20MHz BW, pk-pk			2	%Vset
Transient response (Vset = 5V)	25% to 75% load transient at 1A/uS			0.5	V
	Recovery to within 10% of Vset			100	uS
Turn on rise time	Monotonic 10% to 90%	1.5		3.5	mS
Turn on overshoot				0.1	%Vset
Turn on delay	AC to PG		600	750	mS
	En to PG		15	20	mS
Holdup voltage				5	V
Isolation to ground	Each terminal			250	V
Over current protection	Hiccup mode only	105		130	%rated
Reverse current protection	None				
Short circuit protection (Hiccup mode)	Period		30		mS
	Duty cycle		1		%
Over voltage protection	Latching		8		V
Over Temperature protection	Internally monitored. Latching	115		125	°C
Power Good thresholds	High and Low window	68		120	%Vset
Reliability	25°C, 100% load, Telcordia			1	FPMH
Warranty				2	Years
Wire Size		24	22	20	AWG
Weight				60	Grams
Size	60mm x 35mm x 17mm				

Notes: All specifications are believed to be correct at time of publication and are subject to change without notice.

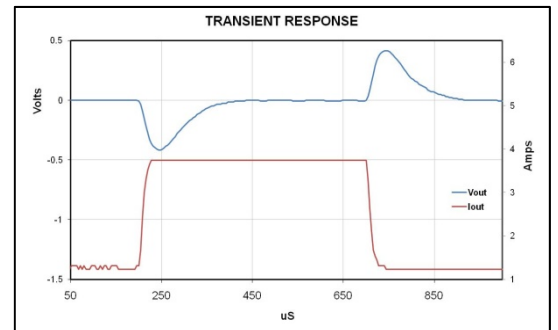
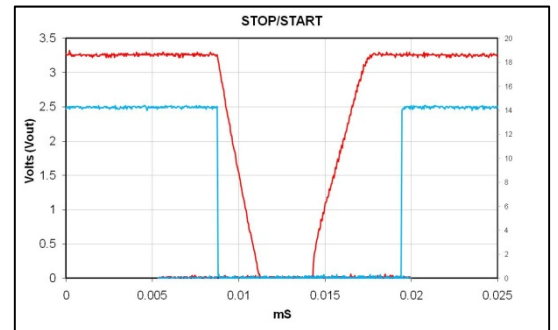
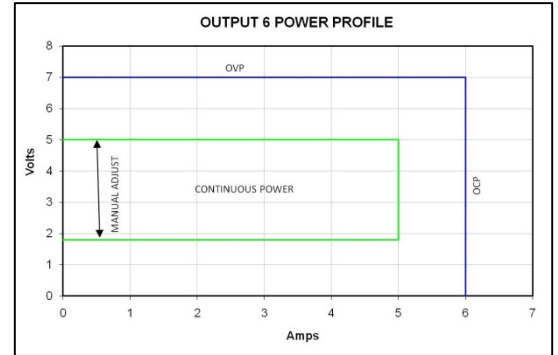

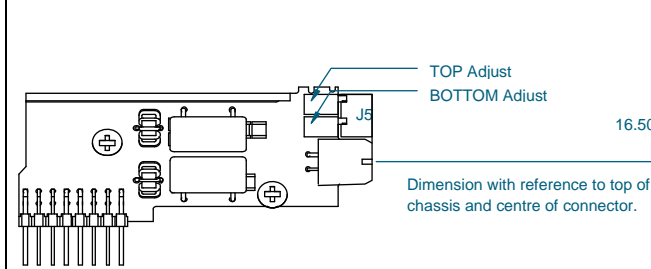

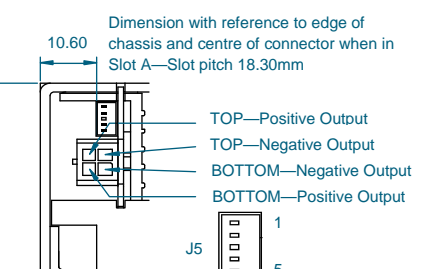

J5	
Circuit	Details
1	Top + Sense
2	Top - Sense
3	Open
4	Bottom + Sense
5	Bottom - Sense

REF.	DETAILS	MANUFACTURER	HOUSING	TERMINAL
J1	OUTPUT POWER CONNECTOR: 4 Pin, with Friction lock, 20-24 AWG	MOLEX	430250400	430300001

Notes: 1. Terminal and Wire current rating must exceed maximum output current. 2. Direct equivalents may be used for any connector parts 3. All cables must be rated 105°C min, equivalent to UL1015

Vox Power Ltd. reserves the right to change or improve any part of the specification, electrical or mechanical design or manufacturing process without notice. Please consult your local distributor or contact Vox Power to ensure that you have the latest specification before using your product. For other information relating to the use of the product please refer to the latest NEVO user manual. Vox Power reserves the right to make changes without notice to any of its products. Vox Power does not assume any liability arising out of the use or application of any of its products and of any information to the maximum extent permitted by law. No license, express or implied, by estoppel or otherwise, to any intellectual property rights is granted by this document or by any conduct of Vox Power. VOX POWER DISCLAIMS ALL WARRANTIES AND REPRESENTATIONS. IN PARTICULAR ALL OTHER WARRANTIES, CONDITION OR TERMS RELATING TO SUITABILITY, FITNESS FOR PURPOSE, MERCHANTABILITY OR CONDITION OF THE PRODUCTS AND WHETHER EXPRESS OR IMPLIED BY STATUTE OR COMMON LAW OR OTHERWISE ARE EXCLUDED.



OUTPUT 7 SPECIFICATIONS

Parameter	Details	Min	Typ	Max	Units
Output voltage range	Top/Bottom channel	1.8/5	3.3/12	5/15	V
Rated current	Each channel			5	A
Rated power	Top/Bottom channel		60/16.5	75/25	Watts
Initial voltage accuracy	Factory set units	-1		1	%
Manual Voltage Adjust	11 turn potentiometer		0.3/0.9		V/turn
Load Regulation	Measured at sense terminals	-50		50	mV
Line Regulation	Measured at sense terminals	-0.1		0.1	%Vnom
Cross Regulation	Measured at sense terminals	-0.2		0.2	%Vnom
Minimum Load				0	Watts
Temperature coefficient		-0.02		0.02	%/°C
Ripple and Noise	20MHz BW, pk-pk			2	%Vset
Transient response (Vset = 5V)	25% to 75% load transient at 1A/uS			1/0.5	V
	Recovery to within 10% of Vset			100	uS
Turn on rise time	Monotonic 10% to 90%	1		3.5	mS
Turn on overshoot				0.1	%Vset
Turn on delay	AC to PG		600	750	mS
	En to PG		15	20	mS
Holdup voltage				12/5	V
Isolation to ground	Each terminal			250	V
Over current protection	Hiccup mode only	105		130	%rated
Reverse current protection	None				
Short circuit protection (Hiccup mode)	Period		30		mS
	Duty cycle		1		%
Over voltage protection	Latching		20/8		V
Over Temperature protection	Internally monitored. Latching	115		125	°C
Power Good thresholds	High and Low window	68		120	%Vset
Reliability	25°C, 100% load, Telcordia			1	FPMH
Warranty				2	Years
Wire Size		24	22	20	AWG
Weight				60	Grams
Size	60mm x 35mm x 17mm				

Notes: All specifications are believed to be correct at time of publication and are subject to change without notice.

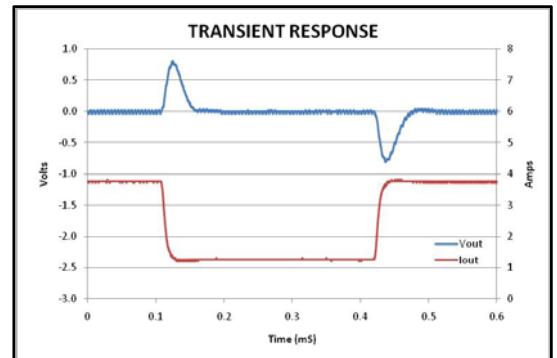
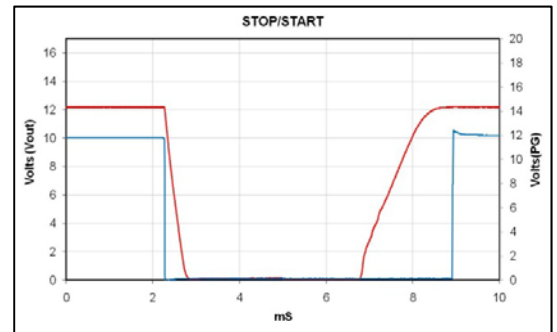
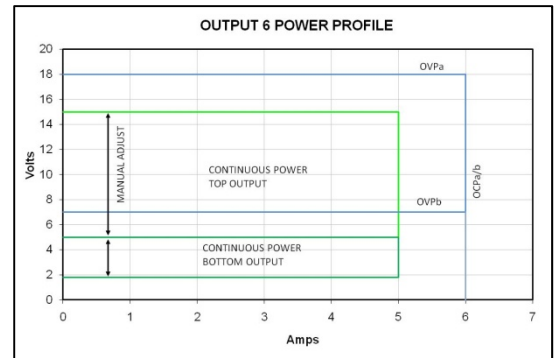

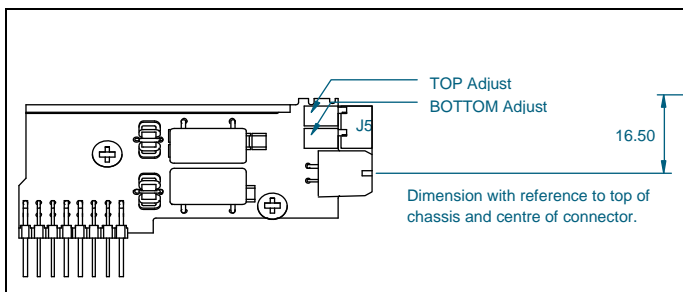

Dimension with reference to edge of chassis and centre of connector when in Slot A—Slot pitch 18.30mm

Dimension with reference to top of chassis and centre of connector.

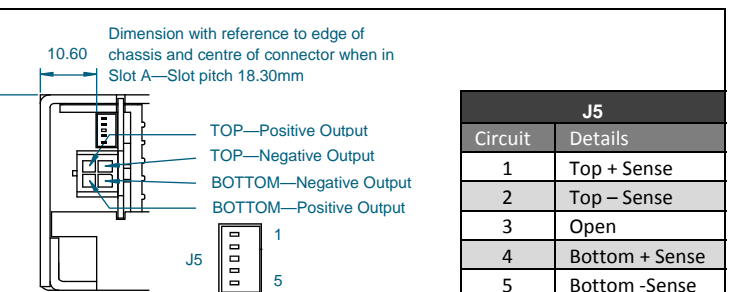

TOP—Positive Output
TOP—Negative Output
BOTTOM—Negative Output
BOTTOM—Positive Output

J5				
Circuit	Details			
1	Top + Sense			
2	Top - Sense			
3	Open			
4	Bottom + Sense			
5	Bottom -Sense			

REF.	DETAILS	MANUFACTURER	HOUSING	TERMINAL
J1	OUTPUT POWER CONNECTOR: 4 Pin, with Friction lock, 20-24 AWG	MOLEX	430250400	430300001

Notes: 1. Terminal and Wire current rating must exceed maximum output current. 2. Direct equivalents may be used for any connector parts 3. All cables must be rated 105°C min, equivalent to UL1015

Vox Power Ltd. reserves the right to change or improve any part of the specification, electrical or mechanical design or manufacturing process without notice. Please consult your local distributor or contact Vox Power to ensure that you have the latest specification before using your product. For other information relating to the use of the product please refer to the latest NEVO user manual. Vox Power reserves the right to make changes without notice to any of its products. Vox Power does not assume any liability arising out of the use or application of any of its products and of any information to the maximum extent permitted by law. No license, express or implied, by estoppel or otherwise, to any intellectual property rights is granted by this document or by any conduct of Vox Power. VOX POWER DISCLAIMS ALL WARRANTIES AND REPRESENTATIONS. IN PARTICULAR ALL OTHER WARRANTIES, CONDITION OR TERMS RELATING TO SUITABILITY, FITNESS FOR PURPOSE, MECHANICALITY OR CONDITION OF THE PRODUCTS AND WHETHER EXPRESS OR IMPLIED BY STATUTE OR COMMON LAW OR OTHERWISE ARE EXCLUDED.